

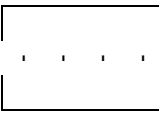

バスケットボール

【男子 予選リーグ・リンク戦 , 女子 決勝 トーナメント戦】 3日(土)

原則として上側に記載のチームがオフィシャルに向かって右側・淡色

| 時間 | 第 1 試合 | 第 2 試合 | 第 3 試合 | 第 4 試合 | 第 5 試合 |
|----------|-----------------------------------------------------------------------------------|-----------------------------------------------------------------------------------|-----------------------------------------------------------------------------------|------------------------------------------------------------------------------------|-------------------------------------------------------------------------------------|
| コート | 9:00 | 10:40 | 12:20 | 14:00 | 15:40 |
| A コート | A - 八 戸 | B - 仙台名取 | A - 秋 田 | B - 一 関 | A - 鶴 岡 |
| |  |  |  |  |  |
| | 秋 田 | 仙台広瀬 | 鶴 岡 | 仙台名取 | 八 戸 |
| B コート | 女子 八 戸 | B - 福 島 | 女子 一 関 | B - 仙台広瀬 | 3位決定戦 |
| |  |  |  |  |  |
| | 仙台名取 | 一 関 | 福 島 | 福 島 | |

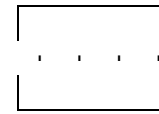
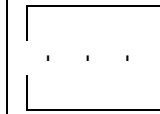
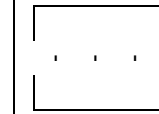
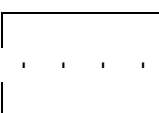
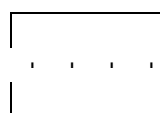
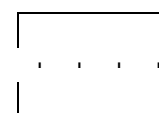
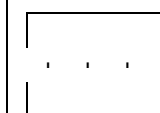
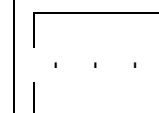
《Aブロック》

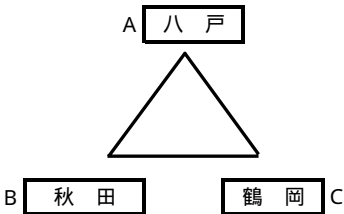

| チーム | 八 戸 | 秋 田 | 鶴 岡 | 勝 | 負 | 総得点 総失点 | 総得点 | 順位 |
|-----|-----|-----|-----|---|---|------------|-----|----|
| 八 戸 | X | | | | | | | |
| 秋 田 | | X | | | | | | |
| 鶴 岡 | | | X | | | | | |

《Bブロック》

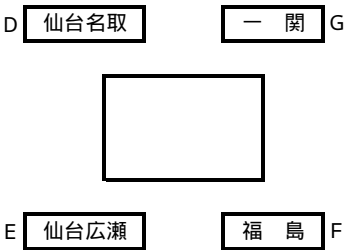

| チーム | 仙台名取 | 仙台広瀬 | 一 関 | 福 島 | 勝 | 負 | 総得点 総失点 | 総得点 | 順位 |
|------|------|------|-----|-----|---|---|------------|-----|----|
| 仙台名取 | X | | | | | | | | |
| 仙台広瀬 | | X | | | | | | | |
| 福 島 | | | X | | | | | | |
| 一 関 | | | | X | | | | | |

《女子 決勝トーナメント戦》

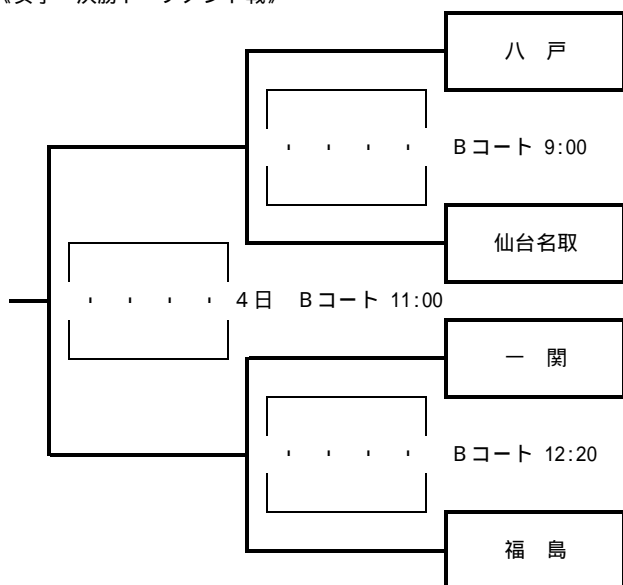

《3位決定戦》

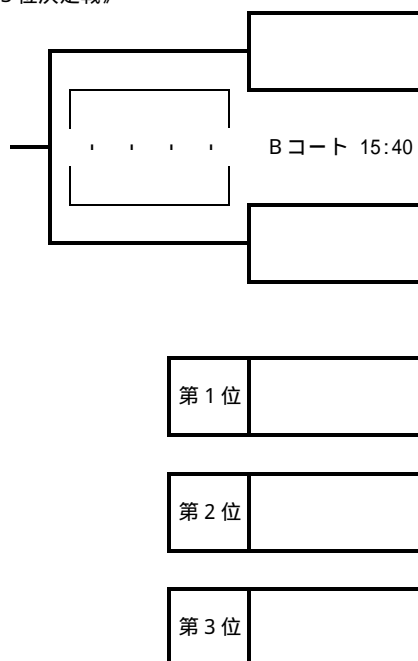

4日(日)

《男子 決勝トーナメント戦》

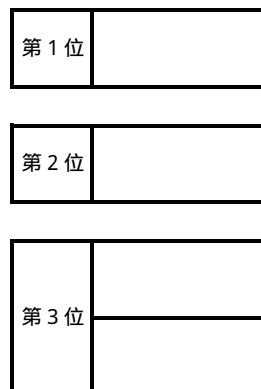
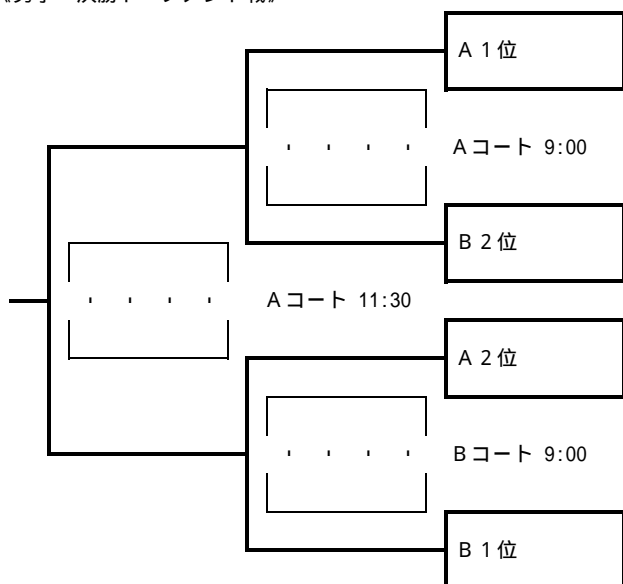

卓 球

【団体戦 予選リーグ・リンク戦】3日(土)

| 時間 コート | 第1試合 9:00 A - | 第2試合 10:00 A - | 第3試合 11:00 A - | | | | | | | | | | | | | | | | | | | | | | | | | | | | | | | | | | | | | | | | | | | | | | | | | | | | | | | | | | | | | | | | | | | | | | | | | | | | | | | | | | | | | | | | | | | | | | | | |
|------------------|--------------------------------------------------------------------------------------------------------------------------------------------------------------------------------------------------------------------------------------------------------------------------------------------------------------------------------------------------------------------------------------------------------------------------------------------------------------------------------------------------------------------------------------------------------------------------------------------------------------------------------------------------------------------------------------------------------------------------------------------------------------------------------------------------------------------------------------------------------------------------------------------------------------------------------------------------------------------------------------------------------------------------------|----------------------|----------------------|-------|---|------------------|-------|---|------------------|--|--|--------|-------|---|------------------|-------|---|------------------|-------|---|------------------|-------|---|-------|---|-------|---|-------|---|-------|---|-------|---|--------------------------------------------------------------------------------------------------------------------------------------------------------------------------------------------------------------------------------------------------------------------------------------------------------------------------------------------------------------------------------------------------------------------------------------------------------------------------------------------------------------------------------------------------------------------------------------------------------------------------------------------------------------------------------------------------------------------------------------------------------------------------------------------------------------------------------------------------------------------------------------------------------------------------------------------------------------------------------------------------------------------------------------------|--|-------|--|--|--|--|--|--|--|--|------------------|-------|---|------------------|-------|---|------------------|-------|---|------------------|-------|---|-------|---|-------|---|-------|---|-------|---|-------|---|--------------------------------------------------------------------------------------------------------------------------------------------------------------------------------------------------------------------------------------------------------------------------------------------------------------------------------------------------------------------------------------------------------------------------------------------------------------------------------------------------------------------------------------------------------------------------------------------------------------------------------------------------------------------------------------------------------------------------------------------------------------------------------------------------------------------------------------------------------------------------------------------------------------------------------------------------------------------------------------------------------|--|-------|--|--|--|--|--|--|--|--|--------|-------|---|--------|-------|---|--------|-------|---|--------|-------|---|-------|---|-------|---|-------|---|-------|---|-------|---|
| 第1 2 コート | <table style="width: 100%; border-collapse: collapse;"> <tr> <td style="width: 10%;"></td> <td style="width: 10%;">(S) -</td> <td style="width: 10%;"></td> <td style="width: 10%;"></td> <td style="width: 10%;"></td> <td style="width: 10%;"></td> <td style="width: 10%;"></td> <td style="width: 10%;"></td> <td style="width: 10%;"></td> <td style="width: 10%;"></td> </tr> <tr> <td rowspan="4" style="vertical-align: middle; font-size: 2em;">福 島</td> <td>(S) -</td> <td>-</td> <td rowspan="4" style="vertical-align: middle; font-size: 2em;">仙 台 名 取</td> <td>(S) -</td> <td>-</td> <td rowspan="4" style="vertical-align: middle; font-size: 2em;">八 戸</td> <td>(S) -</td> <td>-</td> <td rowspan="4" style="vertical-align: middle; font-size: 2em;">福 島</td> </tr> <tr> <td>(W) -</td> <td>-</td> <td>(W) -</td> <td>-</td> </tr> <tr> <td>(S) -</td> <td>-</td> <td>(S) -</td> <td>-</td> </tr> <tr> <td>(S) -</td> <td>-</td> <td>(S) -</td> <td>-</td> </tr> </table> | | (S) - | | | | | | | | | 福 島 | (S) - | - | 仙 台 名 取 | (S) - | - | 八 戸 | (S) - | - | 福 島 | (W) - | - | (W) - | - | (S) - | - | (S) - | - | (S) - | - | (S) - | - | <table style="width: 100%; border-collapse: collapse;"> <tr> <td style="width: 10%;"></td> <td style="width: 10%;">(S) -</td> <td style="width: 10%;"></td> <td style="width: 10%;"></td> <td style="width: 10%;"></td> <td style="width: 10%;"></td> <td style="width: 10%;"></td> <td style="width: 10%;"></td> <td style="width: 10%;"></td> <td style="width: 10%;"></td> </tr> <tr> <td rowspan="4" style="vertical-align: middle; font-size: 2em;">仙 台 名 取</td> <td>(S) -</td> <td>-</td> <td rowspan="4" style="vertical-align: middle; font-size: 2em;">八 戸</td> <td>(S) -</td> <td>-</td> <td rowspan="4" style="vertical-align: middle; font-size: 2em;">福 島</td> <td>(S) -</td> <td>-</td> <td rowspan="4" style="vertical-align: middle; font-size: 2em;">福 島</td> </tr> <tr> <td>(W) -</td> <td>-</td> <td>(W) -</td> <td>-</td> </tr> <tr> <td>(S) -</td> <td>-</td> <td>(S) -</td> <td>-</td> </tr> <tr> <td>(S) -</td> <td>-</td> <td>(S) -</td> <td>-</td> </tr> </table> | | (S) - | | | | | | | | | 仙 台 名 取 | (S) - | - | 八 戸 | (S) - | - | 福 島 | (S) - | - | 福 島 | (W) - | - | (W) - | - | (S) - | - | (S) - | - | (S) - | - | (S) - | - | <table style="width: 100%; border-collapse: collapse;"> <tr> <td style="width: 10%;"></td> <td style="width: 10%;">(S) -</td> <td style="width: 10%;"></td> <td style="width: 10%;"></td> <td style="width: 10%;"></td> <td style="width: 10%;"></td> <td style="width: 10%;"></td> <td style="width: 10%;"></td> <td style="width: 10%;"></td> <td style="width: 10%;"></td> </tr> <tr> <td rowspan="4" style="vertical-align: middle; font-size: 2em;">八 戸</td> <td>(S) -</td> <td>-</td> <td rowspan="4" style="vertical-align: middle; font-size: 2em;">福 島</td> <td>(S) -</td> <td>-</td> <td rowspan="4" style="vertical-align: middle; font-size: 2em;">福 島</td> <td>(S) -</td> <td>-</td> <td rowspan="4" style="vertical-align: middle; font-size: 2em;">福 島</td> </tr> <tr> <td>(W) -</td> <td>-</td> <td>(W) -</td> <td>-</td> </tr> <tr> <td>(S) -</td> <td>-</td> <td>(S) -</td> <td>-</td> </tr> <tr> <td>(S) -</td> <td>-</td> <td>(S) -</td> <td>-</td> </tr> </table> | | (S) - | | | | | | | | | 八 戸 | (S) - | - | 福 島 | (S) - | - | 福 島 | (S) - | - | 福 島 | (W) - | - | (W) - | - | (S) - | - | (S) - | - | (S) - | - | (S) - | - |
| | | (S) - | | | | | | | | | | | | | | | | | | | | | | | | | | | | | | | | | | | | | | | | | | | | | | | | | | | | | | | | | | | | | | | | | | | | | | | | | | | | | | | | | | | | | | | | | | | | | | | | | |
| 福 島 | (S) - | - | 仙 台 名 取 | (S) - | - | 八 戸 | (S) - | - | 福 島 | | | | | | | | | | | | | | | | | | | | | | | | | | | | | | | | | | | | | | | | | | | | | | | | | | | | | | | | | | | | | | | | | | | | | | | | | | | | | | | | | | | | | | | | | | |
| | (W) - | - | | (W) - | - | | | | | | | | | | | | | | | | | | | | | | | | | | | | | | | | | | | | | | | | | | | | | | | | | | | | | | | | | | | | | | | | | | | | | | | | | | | | | | | | | | | | | | | | | | | | | | |
| | (S) - | - | | (S) - | - | | | | | | | | | | | | | | | | | | | | | | | | | | | | | | | | | | | | | | | | | | | | | | | | | | | | | | | | | | | | | | | | | | | | | | | | | | | | | | | | | | | | | | | | | | | | | | |
| | (S) - | - | | (S) - | - | | | | | | | | | | | | | | | | | | | | | | | | | | | | | | | | | | | | | | | | | | | | | | | | | | | | | | | | | | | | | | | | | | | | | | | | | | | | | | | | | | | | | | | | | | | | | | |
| | (S) - | | | | | | | | | | | | | | | | | | | | | | | | | | | | | | | | | | | | | | | | | | | | | | | | | | | | | | | | | | | | | | | | | | | | | | | | | | | | | | | | | | | | | | | | | | | | | | | | | | |
| 仙 台 名 取 | (S) - | - | 八 戸 | (S) - | - | 福 島 | (S) - | - | 福 島 | | | | | | | | | | | | | | | | | | | | | | | | | | | | | | | | | | | | | | | | | | | | | | | | | | | | | | | | | | | | | | | | | | | | | | | | | | | | | | | | | | | | | | | | | | |
| | (W) - | - | | (W) - | - | | | | | | | | | | | | | | | | | | | | | | | | | | | | | | | | | | | | | | | | | | | | | | | | | | | | | | | | | | | | | | | | | | | | | | | | | | | | | | | | | | | | | | | | | | | | | | |
| | (S) - | - | | (S) - | - | | | | | | | | | | | | | | | | | | | | | | | | | | | | | | | | | | | | | | | | | | | | | | | | | | | | | | | | | | | | | | | | | | | | | | | | | | | | | | | | | | | | | | | | | | | | | | |
| | (S) - | - | | (S) - | - | | | | | | | | | | | | | | | | | | | | | | | | | | | | | | | | | | | | | | | | | | | | | | | | | | | | | | | | | | | | | | | | | | | | | | | | | | | | | | | | | | | | | | | | | | | | | | |
| | (S) - | | | | | | | | | | | | | | | | | | | | | | | | | | | | | | | | | | | | | | | | | | | | | | | | | | | | | | | | | | | | | | | | | | | | | | | | | | | | | | | | | | | | | | | | | | | | | | | | | | |
| 八 戸 | (S) - | - | 福 島 | (S) - | - | 福 島 | (S) - | - | 福 島 | | | | | | | | | | | | | | | | | | | | | | | | | | | | | | | | | | | | | | | | | | | | | | | | | | | | | | | | | | | | | | | | | | | | | | | | | | | | | | | | | | | | | | | | | | |
| | (W) - | - | | (W) - | - | | | | | | | | | | | | | | | | | | | | | | | | | | | | | | | | | | | | | | | | | | | | | | | | | | | | | | | | | | | | | | | | | | | | | | | | | | | | | | | | | | | | | | | | | | | | | | |
| | (S) - | - | | (S) - | - | | | | | | | | | | | | | | | | | | | | | | | | | | | | | | | | | | | | | | | | | | | | | | | | | | | | | | | | | | | | | | | | | | | | | | | | | | | | | | | | | | | | | | | | | | | | | | |
| | (S) - | - | | (S) - | - | | | | | | | | | | | | | | | | | | | | | | | | | | | | | | | | | | | | | | | | | | | | | | | | | | | | | | | | | | | | | | | | | | | | | | | | | | | | | | | | | | | | | | | | | | | | | | |
| 第4 5 コート | <table style="width: 100%; border-collapse: collapse;"> <tr> <td style="width: 10%;"></td> <td style="width: 10%;">(S) -</td> <td style="width: 10%;"></td> <td style="width: 10%;"></td> <td style="width: 10%;"></td> <td style="width: 10%;"></td> <td style="width: 10%;"></td> <td style="width: 10%;"></td> <td style="width: 10%;"></td> <td style="width: 10%;"></td> </tr> <tr> <td rowspan="4" style="vertical-align: middle; font-size: 2em;">一 関</td> <td>(S) -</td> <td>-</td> <td rowspan="4" style="vertical-align: middle; font-size: 2em;">鶴 岡</td> <td>(S) -</td> <td>-</td> <td rowspan="4" style="vertical-align: middle; font-size: 2em;">仙 台 広 瀬</td> <td>(S) -</td> <td>-</td> <td rowspan="4" style="vertical-align: middle; font-size: 2em;">仙 台 広 瀬</td> </tr> <tr> <td>(W) -</td> <td>-</td> <td>(W) -</td> <td>-</td> </tr> <tr> <td>(S) -</td> <td>-</td> <td>(S) -</td> <td>-</td> </tr> <tr> <td>(S) -</td> <td>-</td> <td>(S) -</td> <td>-</td> </tr> </table> | | (S) - | | | | | | | | | 一 関 | (S) - | - | 鶴 岡 | (S) - | - | 仙 台 広 瀬 | (S) - | - | 仙 台 広 瀬 | (W) - | - | (W) - | - | (S) - | - | (S) - | - | (S) - | - | (S) - | - | <table style="width: 100%; border-collapse: collapse;"> <tr> <td style="width: 10%;"></td> <td style="width: 10%;">(S) -</td> <td style="width: 10%;"></td> <td style="width: 10%;"></td> <td style="width: 10%;"></td> <td style="width: 10%;"></td> <td style="width: 10%;"></td> <td style="width: 10%;"></td> <td style="width: 10%;"></td> <td style="width: 10%;"></td> </tr> <tr> <td rowspan="4" style="vertical-align: middle; font-size: 2em;">一 関</td> <td>(S) -</td> <td>-</td> <td rowspan="4" style="vertical-align: middle; font-size: 2em;">仙 台 広 瀬</td> <td>(S) -</td> <td>-</td> <td rowspan="4" style="vertical-align: middle; font-size: 2em;">仙 台 広 瀬</td> <td>(S) -</td> <td>-</td> <td rowspan="4" style="vertical-align: middle; font-size: 2em;">仙 台 広 瀬</td> </tr> <tr> <td>(W) -</td> <td>-</td> <td>(W) -</td> <td>-</td> </tr> <tr> <td>(S) -</td> <td>-</td> <td>(S) -</td> <td>-</td> </tr> <tr> <td>(S) -</td> <td>-</td> <td>(S) -</td> <td>-</td> </tr> </table> | | (S) - | | | | | | | | | 一 関 | (S) - | - | 仙 台 広 瀬 | (S) - | - | 仙 台 広 瀬 | (S) - | - | 仙 台 広 瀬 | (W) - | - | (W) - | - | (S) - | - | (S) - | - | (S) - | - | (S) - | - | | | | | | | | | | | | | | | | | | | | | | | | | | | | | | | | | |
| | | (S) - | | | | | | | | | | | | | | | | | | | | | | | | | | | | | | | | | | | | | | | | | | | | | | | | | | | | | | | | | | | | | | | | | | | | | | | | | | | | | | | | | | | | | | | | | | | | | | | | | |
| 一 関 | (S) - | - | 鶴 岡 | (S) - | - | 仙 台 広 瀬 | (S) - | - | 仙 台 広 瀬 | | | | | | | | | | | | | | | | | | | | | | | | | | | | | | | | | | | | | | | | | | | | | | | | | | | | | | | | | | | | | | | | | | | | | | | | | | | | | | | | | | | | | | | | | | |
| | (W) - | - | | (W) - | - | | | | | | | | | | | | | | | | | | | | | | | | | | | | | | | | | | | | | | | | | | | | | | | | | | | | | | | | | | | | | | | | | | | | | | | | | | | | | | | | | | | | | | | | | | | | | | |
| | (S) - | - | | (S) - | - | | | | | | | | | | | | | | | | | | | | | | | | | | | | | | | | | | | | | | | | | | | | | | | | | | | | | | | | | | | | | | | | | | | | | | | | | | | | | | | | | | | | | | | | | | | | | | |
| | (S) - | - | | (S) - | - | | | | | | | | | | | | | | | | | | | | | | | | | | | | | | | | | | | | | | | | | | | | | | | | | | | | | | | | | | | | | | | | | | | | | | | | | | | | | | | | | | | | | | | | | | | | | | |
| | (S) - | | | | | | | | | | | | | | | | | | | | | | | | | | | | | | | | | | | | | | | | | | | | | | | | | | | | | | | | | | | | | | | | | | | | | | | | | | | | | | | | | | | | | | | | | | | | | | | | | | |
| 一 関 | (S) - | - | 仙 台 広 瀬 | (S) - | - | 仙 台 広 瀬 | (S) - | - | 仙 台 広 瀬 | | | | | | | | | | | | | | | | | | | | | | | | | | | | | | | | | | | | | | | | | | | | | | | | | | | | | | | | | | | | | | | | | | | | | | | | | | | | | | | | | | | | | | | | | | |
| | (W) - | - | | (W) - | - | | | | | | | | | | | | | | | | | | | | | | | | | | | | | | | | | | | | | | | | | | | | | | | | | | | | | | | | | | | | | | | | | | | | | | | | | | | | | | | | | | | | | | | | | | | | | | |
| | (S) - | - | | (S) - | - | | | | | | | | | | | | | | | | | | | | | | | | | | | | | | | | | | | | | | | | | | | | | | | | | | | | | | | | | | | | | | | | | | | | | | | | | | | | | | | | | | | | | | | | | | | | | | |
| | (S) - | - | | (S) - | - | | | | | | | | | | | | | | | | | | | | | | | | | | | | | | | | | | | | | | | | | | | | | | | | | | | | | | | | | | | | | | | | | | | | | | | | | | | | | | | | | | | | | | | | | | | | | | |
| 第7 8 コート | <table style="width: 100%; border-collapse: collapse;"> <tr> <td style="width: 10%;"></td> <td style="width: 10%;">(S) -</td> <td style="width: 10%;"></td> <td style="width: 10%;"></td> <td style="width: 10%;"></td> <td style="width: 10%;"></td> <td style="width: 10%;"></td> <td style="width: 10%;"></td> <td style="width: 10%;"></td> <td style="width: 10%;"></td> </tr> <tr> <td rowspan="4" style="vertical-align: middle; font-size: 2em;">秋 田</td> <td>(S) -</td> <td>-</td> <td rowspan="4" style="vertical-align: middle; font-size: 2em;">仙 台 広 瀬</td> <td>(S) -</td> <td>-</td> <td rowspan="4" style="vertical-align: middle; font-size: 2em;">秋 田</td> <td>(S) -</td> <td>-</td> <td rowspan="4" style="vertical-align: middle; font-size: 2em;">秋 田</td> </tr> <tr> <td>(W) -</td> <td>-</td> <td>(W) -</td> <td>-</td> </tr> <tr> <td>(S) -</td> <td>-</td> <td>(S) -</td> <td>-</td> </tr> <tr> <td>(S) -</td> <td>-</td> <td>(S) -</td> <td>-</td> </tr> </table> | | (S) - | | | | | | | | | 秋 田 | (S) - | - | 仙 台 広 瀬 | (S) - | - | 秋 田 | (S) - | - | 秋 田 | (W) - | - | (W) - | - | (S) - | - | (S) - | - | (S) - | - | (S) - | - | <table style="width: 100%; border-collapse: collapse;"> <tr> <td style="width: 10%;"></td> <td style="width: 10%;">(S) -</td> <td style="width: 10%;"></td> <td style="width: 10%;"></td> <td style="width: 10%;"></td> <td style="width: 10%;"></td> <td style="width: 10%;"></td> <td style="width: 10%;"></td> <td style="width: 10%;"></td> <td style="width: 10%;"></td> </tr> <tr> <td rowspan="4" style="vertical-align: middle; font-size: 2em;">鶴 岡</td> <td>(S) -</td> <td>-</td> <td rowspan="4" style="vertical-align: middle; font-size: 2em;">秋 田</td> <td>(S) -</td> <td>-</td> <td rowspan="4" style="vertical-align: middle; font-size: 2em;">秋 田</td> <td>(S) -</td> <td>-</td> <td rowspan="4" style="vertical-align: middle; font-size: 2em;">秋 田</td> </tr> <tr> <td>(W) -</td> <td>-</td> <td>(W) -</td> <td>-</td> </tr> <tr> <td>(S) -</td> <td>-</td> <td>(S) -</td> <td>-</td> </tr> <tr> <td>(S) -</td> <td>-</td> <td>(S) -</td> <td>-</td> </tr> </table> | | (S) - | | | | | | | | | 鶴 岡 | (S) - | - | 秋 田 | (S) - | - | 秋 田 | (S) - | - | 秋 田 | (W) - | - | (W) - | - | (S) - | - | (S) - | - | (S) - | - | (S) - | - | | | | | | | | | | | | | | | | | | | | | | | | | | | | | | | | | |
| | | (S) - | | | | | | | | | | | | | | | | | | | | | | | | | | | | | | | | | | | | | | | | | | | | | | | | | | | | | | | | | | | | | | | | | | | | | | | | | | | | | | | | | | | | | | | | | | | | | | | | | |
| 秋 田 | (S) - | - | 仙 台 広 瀬 | (S) - | - | 秋 田 | (S) - | - | 秋 田 | | | | | | | | | | | | | | | | | | | | | | | | | | | | | | | | | | | | | | | | | | | | | | | | | | | | | | | | | | | | | | | | | | | | | | | | | | | | | | | | | | | | | | | | | | |
| | (W) - | - | | (W) - | - | | | | | | | | | | | | | | | | | | | | | | | | | | | | | | | | | | | | | | | | | | | | | | | | | | | | | | | | | | | | | | | | | | | | | | | | | | | | | | | | | | | | | | | | | | | | | | |
| | (S) - | - | | (S) - | - | | | | | | | | | | | | | | | | | | | | | | | | | | | | | | | | | | | | | | | | | | | | | | | | | | | | | | | | | | | | | | | | | | | | | | | | | | | | | | | | | | | | | | | | | | | | | | |
| | (S) - | - | | (S) - | - | | | | | | | | | | | | | | | | | | | | | | | | | | | | | | | | | | | | | | | | | | | | | | | | | | | | | | | | | | | | | | | | | | | | | | | | | | | | | | | | | | | | | | | | | | | | | | |
| | (S) - | | | | | | | | | | | | | | | | | | | | | | | | | | | | | | | | | | | | | | | | | | | | | | | | | | | | | | | | | | | | | | | | | | | | | | | | | | | | | | | | | | | | | | | | | | | | | | | | | | |
| 鶴 岡 | (S) - | - | 秋 田 | (S) - | - | 秋 田 | (S) - | - | 秋 田 | | | | | | | | | | | | | | | | | | | | | | | | | | | | | | | | | | | | | | | | | | | | | | | | | | | | | | | | | | | | | | | | | | | | | | | | | | | | | | | | | | | | | | | | | | |
| | (W) - | - | | (W) - | - | | | | | | | | | | | | | | | | | | | | | | | | | | | | | | | | | | | | | | | | | | | | | | | | | | | | | | | | | | | | | | | | | | | | | | | | | | | | | | | | | | | | | | | | | | | | | | |
| | (S) - | - | | (S) - | - | | | | | | | | | | | | | | | | | | | | | | | | | | | | | | | | | | | | | | | | | | | | | | | | | | | | | | | | | | | | | | | | | | | | | | | | | | | | | | | | | | | | | | | | | | | | | | |
| | (S) - | - | | (S) - | - | | | | | | | | | | | | | | | | | | | | | | | | | | | | | | | | | | | | | | | | | | | | | | | | | | | | | | | | | | | | | | | | | | | | | | | | | | | | | | | | | | | | | | | | | | | | | | |

《Aブロック》

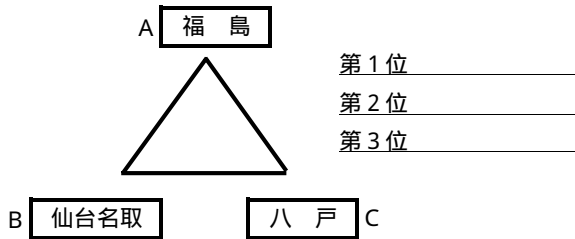

《Bブロック》

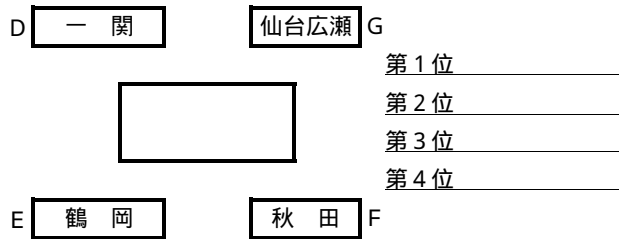

【男子 決勝トーナメント戦】 3日(土)

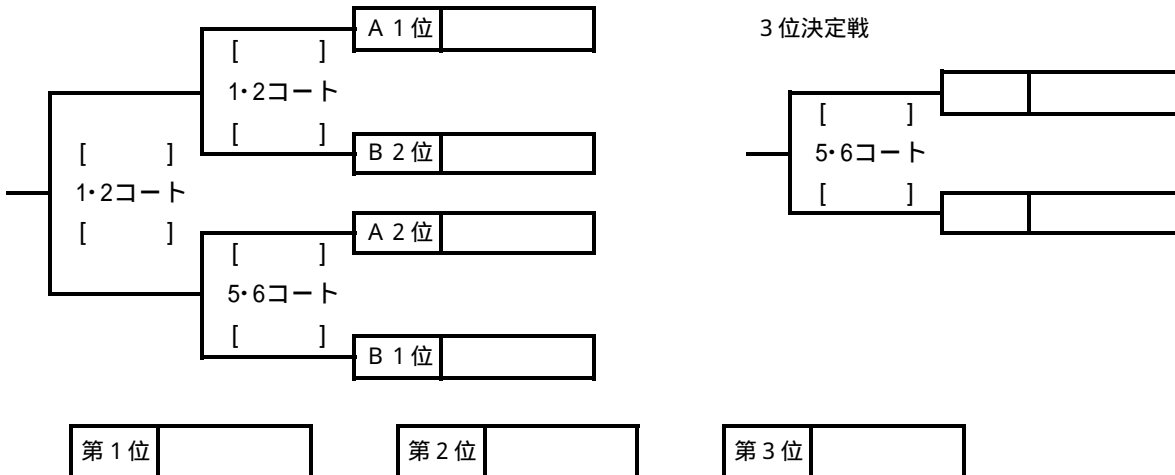

卓球個人シングルス戦抽選

| | | | | | | | | | | | | | | | | | |
|---|------|----|---|---|----|---|----|---|----|---|----|---|----|---|----|---|----|
| A | 福島 | 高専 | 1 | ・ | 10 | ・ | 18 | ・ | 24 | ・ | 34 | ・ | 37 | ・ | 49 | ・ | 52 |
| B | 八戸 | 高専 | 2 | ・ | 14 | ・ | 20 | ・ | 22 | ・ | 30 | ・ | 40 | ・ | 48 | ・ | 53 |
| C | 一関 | 高専 | 3 | ・ | 12 | ・ | 15 | ・ | 26 | ・ | 32 | ・ | 36 | ・ | 44 | ・ | 50 |
| D | 仙台名取 | 高専 | 4 | ・ | 13 | ・ | 16 | ・ | 28 | ・ | 35 | ・ | 41 | ・ | 46 | ・ | 51 |
| E | 秋田 | 高専 | 5 | ・ | 9 | ・ | 21 | ・ | 25 | ・ | 29 | ・ | 38 | ・ | 45 | ・ | 54 |
| F | 鶴岡 | 高専 | 6 | ・ | 8 | ・ | 19 | ・ | 27 | ・ | 31 | ・ | 42 | ・ | 47 | ・ | 55 |
| G | 仙台広瀬 | 高専 | 7 | ・ | 11 | ・ | 17 | ・ | 23 | ・ | 33 | ・ | 39 | ・ | 43 | ・ | 56 |

卓球個人ダブルス戦抽選

| | | | | | |
|---|------|----|---|---|----|
| A | 鶴岡 | 高専 | 1 | ・ | 8 |
| B | 一関 | 高専 | 2 | ・ | 14 |
| C | 福島 | 高専 | 3 | ・ | 10 |
| D | 仙台名取 | 高専 | 4 | ・ | 13 |
| E | 八戸 | 高専 | 5 | ・ | 9 |
| F | 秋田 | 高専 | 6 | ・ | 12 |
| G | 仙台広瀬 | 高専 | 7 | ・ | 11 |

【卓球個人戦】(3,4日)
[シングルス]

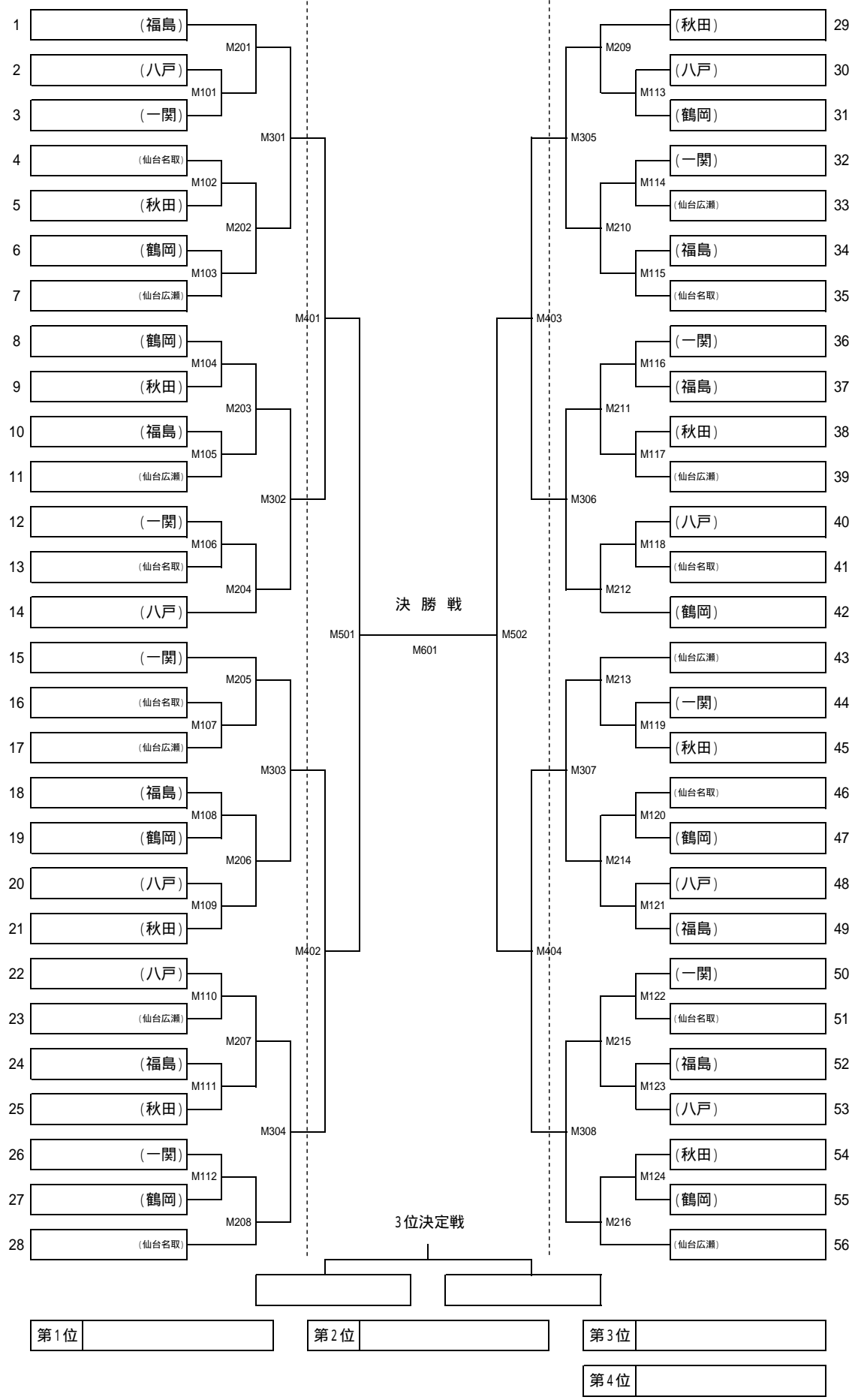

【卓球個人戦】（3, 4日）
[ダブルス]

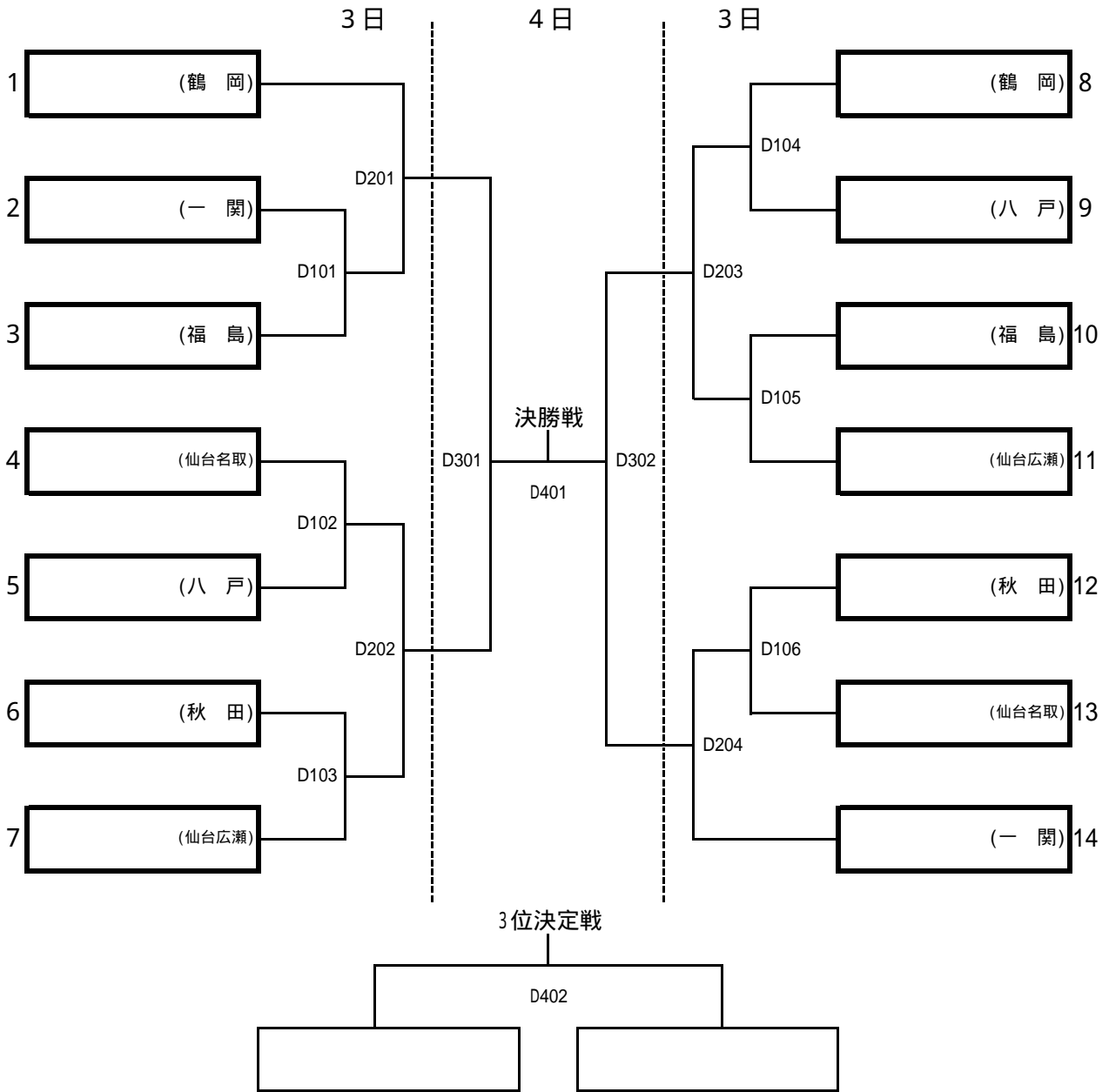

第1位 ()

第2位 ()

第3位 ()

第4位 ()

剣 道

【団体戦・リーグ戦（3日）】

| | 第1試合場 順 序 | 9:30 | | | | | | | | | | 勝 数 | 勝 者 数 | 総 本 数 | 順 位 |
|---|--------------|------|---|---|---|---|---|---|---|---|----|--------|-------------|-------------|--------|
| | | 1 | 2 | 3 | 4 | 5 | 6 | 7 | 8 | 9 | 10 | | | | |
| | 第2試合場 順 序 | | | | | | | | | | | | | | |
| | | 1 | 2 | 3 | 4 | 5 | 6 | 7 | 8 | 9 | 10 | | | | |
| A | 仙台名取 | | | | | | | | | | | | | | |
| B | 一 関 | | | | | | | | | | | | | | |
| C | 仙台広瀬 | | | | | | | | | | | | | | |
| D | 秋 田 | | | | | | | | | | | | | | |
| E | 福 島 | | | | | | | | | | | | | | |
| F | 鶴 岡 | | | | | | | | | | | | | | |
| G | 八 戸 | | | | | | | | | | | | | | |

第1位

第2位

第3位

剣道個人戦抽選

| | | | |
|---|------|----|---------------------|
| A | 仙台名取 | 高専 | 4・9・17・20・27・37・49 |
| B | 鶴岡 | 高専 | 5・14・21・29・33・39・44 |
| C | 秋田 | 高専 | 6・10・25・26・36・42・47 |
| D | 一関 | 高専 | 1・12・15・28・34・43・48 |
| E | 仙台広瀬 | 高専 | 2・11・19・23・30・35・38 |
| F | 福島 | 高専 | 3・8・18・22・31・41・45 |
| G | 八戸 | 高専 | 7・13・16・24・32・40・46 |

【 男子個人戦(4日) 】

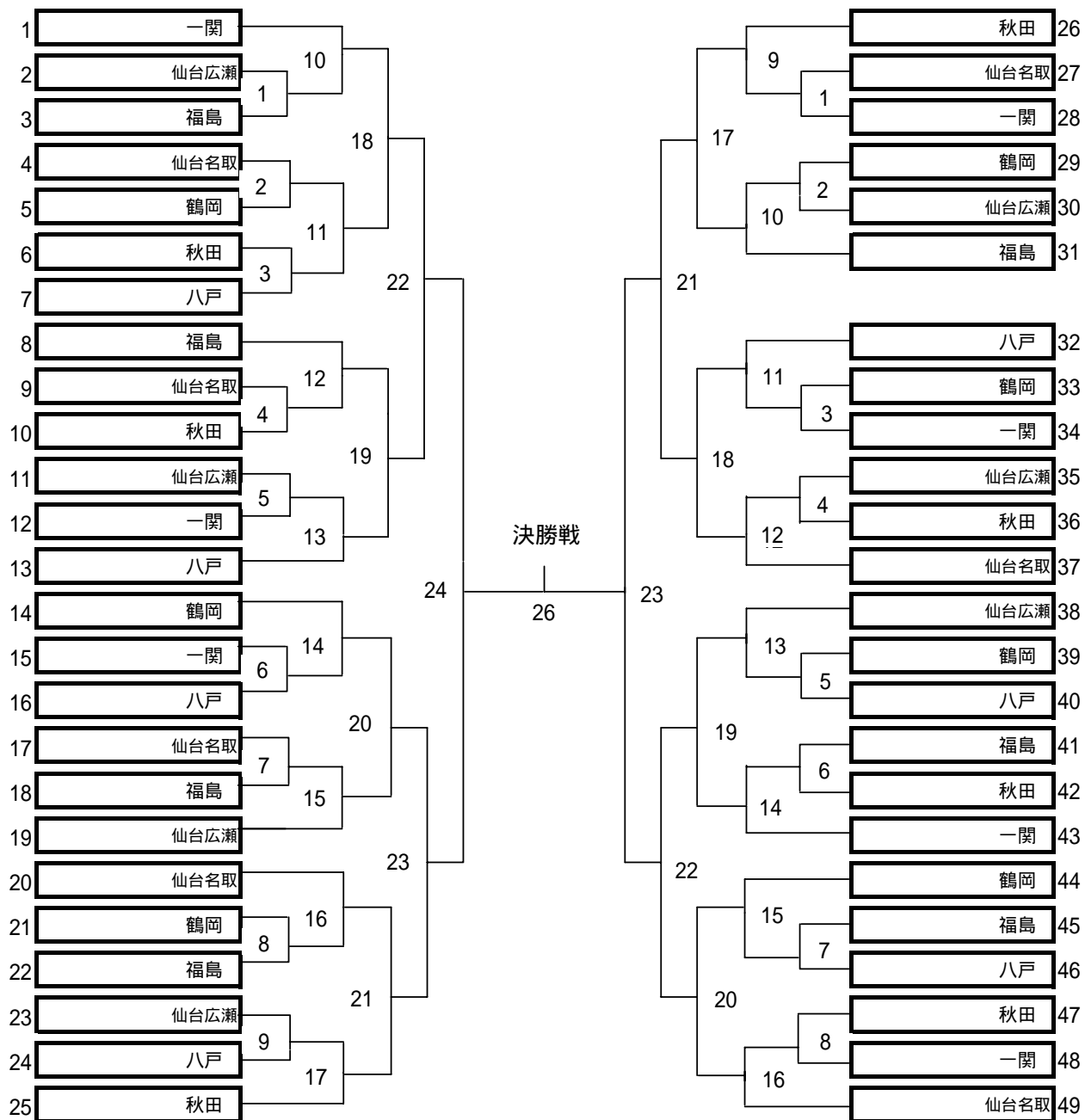

3位決定戦

25

() ()

第1位 () 第2位 () 第3位 ()

第4位 ()

テニ ス

【団体戦】予選リーグ・リンク戦（3日）

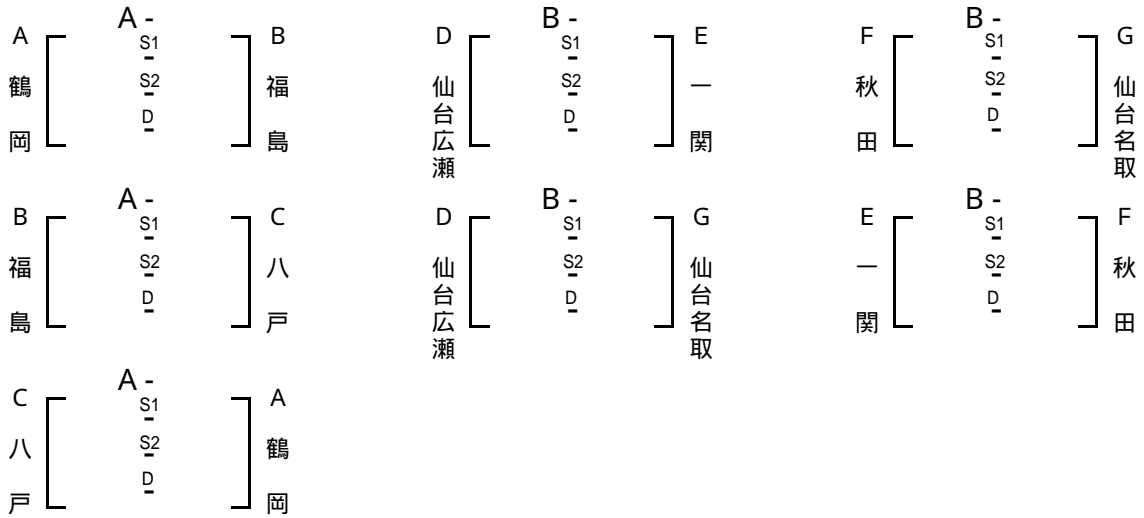

《Aブロック》

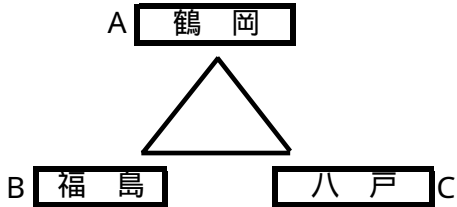

《Bブロック》

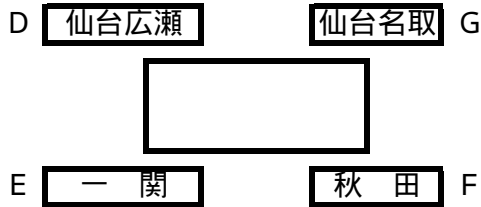

決勝トーナメント（3日）

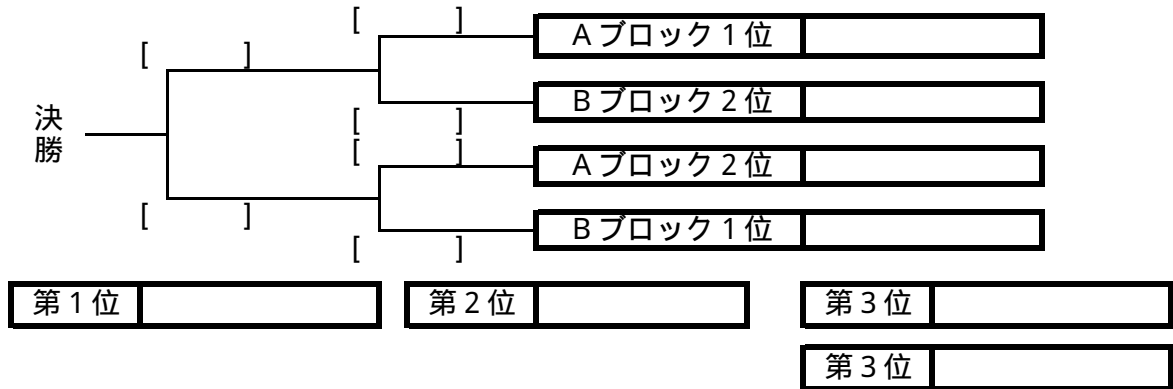

（雨天の場合）

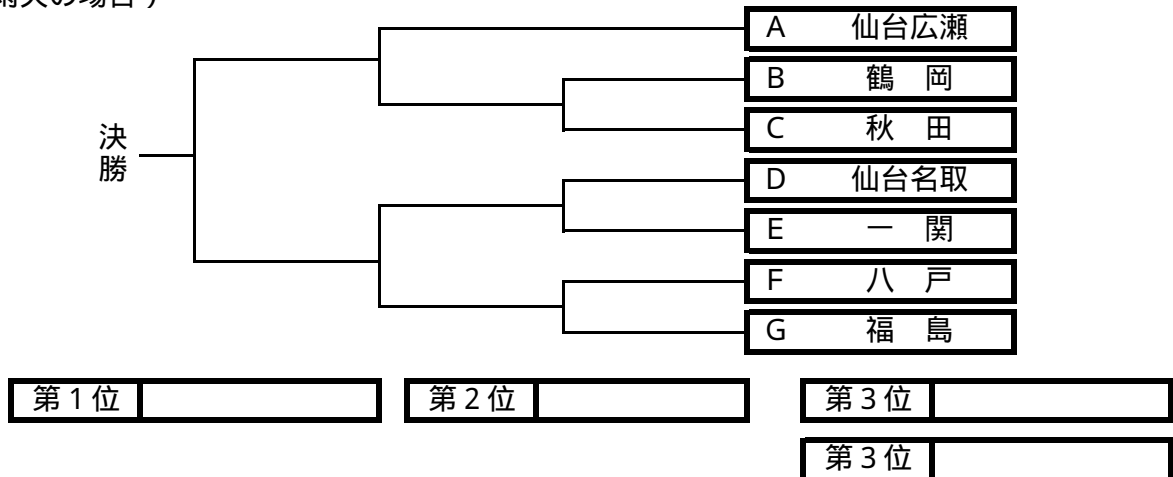

【女子団体戦】（3日）

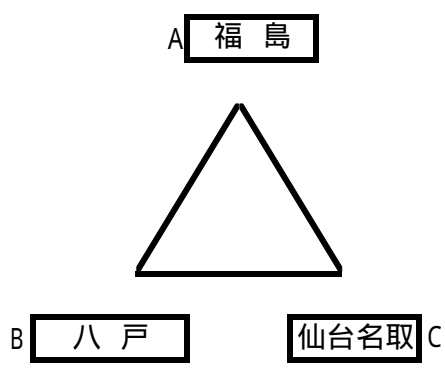
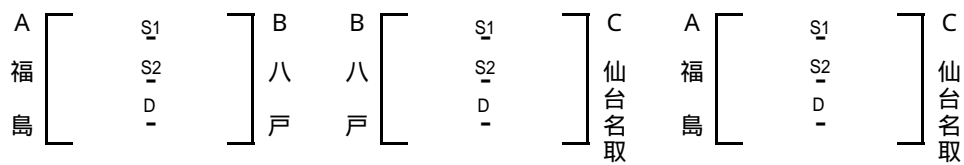

| 学校名 | 福島 | 八戸 | 仙台名取 | 勝敗 |
|--------|----|----|------|----|
| A 福島 | | | | - |
| B 八戸 | | | | - |
| C 仙台名取 | | | | - |

第1位

第2位

第3位

バドミントン

【男子団体戦】(MT) 3日

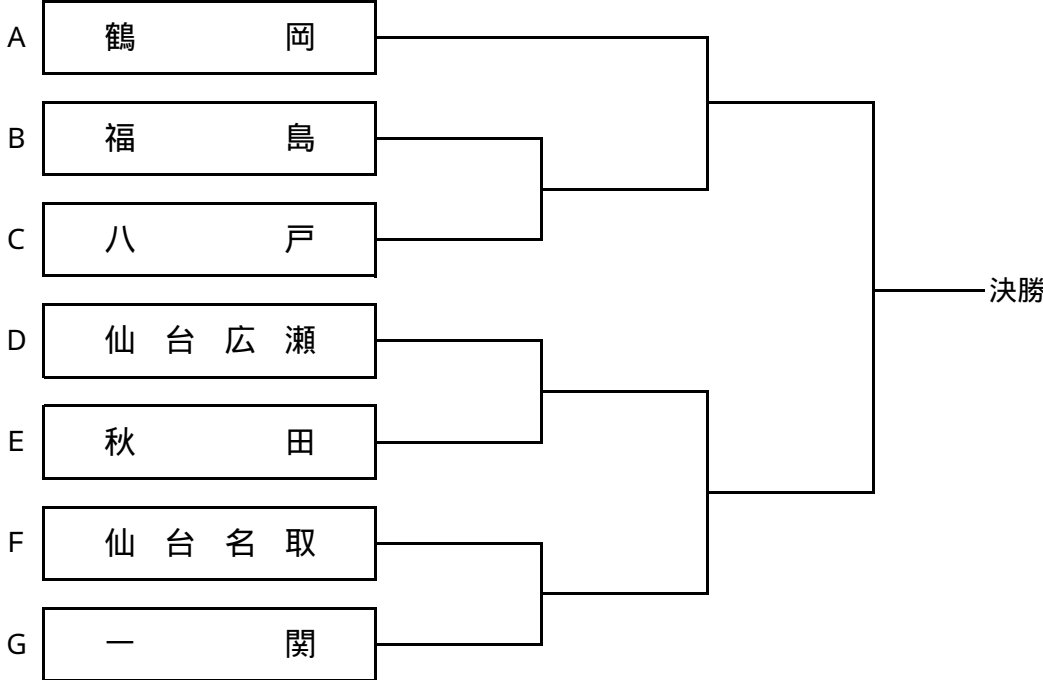

第 1 位

第 2 位

第 3 位

【女子団体戦】(LT) 3日

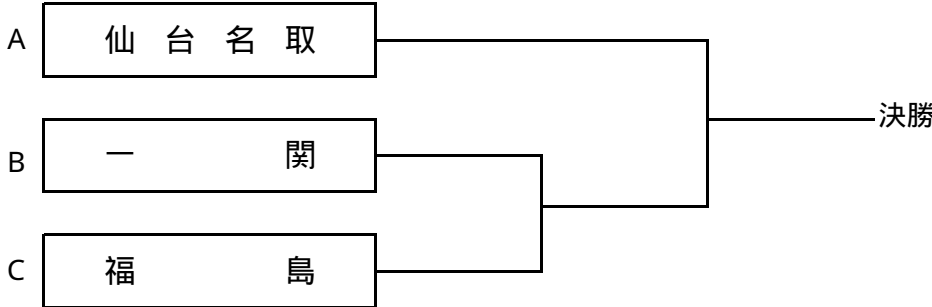

第 1 位

第 2 位

第 3 位

ラグビーフットボール

試合時間:
一回戦 30分ハーフ
準決勝以降 35分ハーフ

決 勝

10月19日(火)

11:00 ~

[審判:]

| 前半 | 後半 | | 前半 | 後半 |
|----|----|----|----|----|
| | | T | | |
| | | G | | |
| | | PG | | |
| | | DG | | |
| | | 小計 | | |
| | | 反則 | | |
| | | 計 | | |

10月17日(日)

11:30 ~

[審判:]

| 前半 | 後半 | | 前半 | 後半 |
|----|----|----|----|----|
| | | T | | |
| | | G | | |
| | | PG | | |
| | | DG | | |
| | | 小計 | | |
| | | 反則 | | |
| | | 計 | | |

10月17日(日)

13:00 ~

[審判:]

| 前半 | 後半 | | 前半 | 後半 |
|----|----|----|----|----|
| | | T | | |
| | | G | | |
| | | PG | | |
| | | DG | | |
| | | 小計 | | |
| | | 反則 | | |
| | | 計 | | |

10月16日(土)

11:30 ~

[審判:]

| 前半 | 後半 | | 前半 | 後半 |
|----|----|----|----|----|
| | | T | | |
| | | G | | |
| | | PG | | |
| | | DG | | |
| | | 小計 | | |
| | | 反則 | | |
| | | 計 | | |

10月16日(土)

12:50 ~

[審判:]

| 前半 | 後半 | | 前半 | 後半 |
|----|----|----|----|----|
| | | T | | |
| | | G | | |
| | | PG | | |
| | | DG | | |
| | | 小計 | | |
| | | 反則 | | |
| | | 計 | | |

仙台高専名取

A

秋田高専

B

福島高専

C

仙台高専広瀬

D

八戸高専

E

鶴岡高専

F